

Entría Single-Door Controller: Mullion Installation Guide

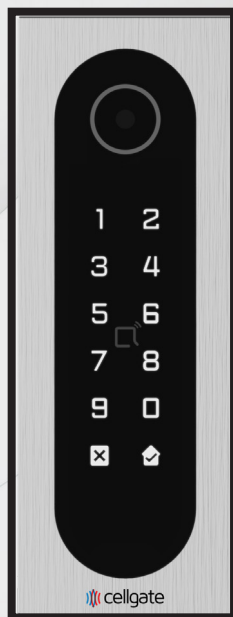

Updated November 2025





Contents

Wiring Overview..... 3

Wiring Labels..... 4

Dry Contact Relays..... 4

Wet Contact Relays..... 5

Mounting..... 6

Items Included

- Entria Unit
- 12 Volt / 5 amp Power Supply
- Customer Information Packet

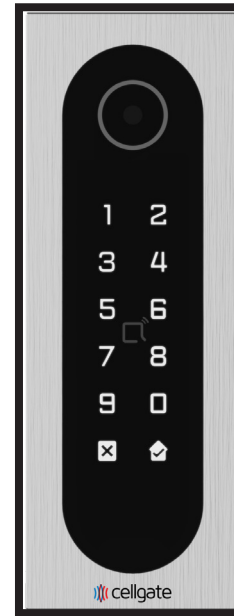

Power Wiring Guidelines	
Gauge Wire	Wire Run
18	25 feet
16	50 feet
12	60 feet



Operating Temperatures
 -20° to 55° C
 -4° to 131° F

We do not recommend running wires over 60 feet.

Required wiring: 6 conductor stranded and shielded for main device.
Pay attention to polarity. The system uses DC





Wiring Overview

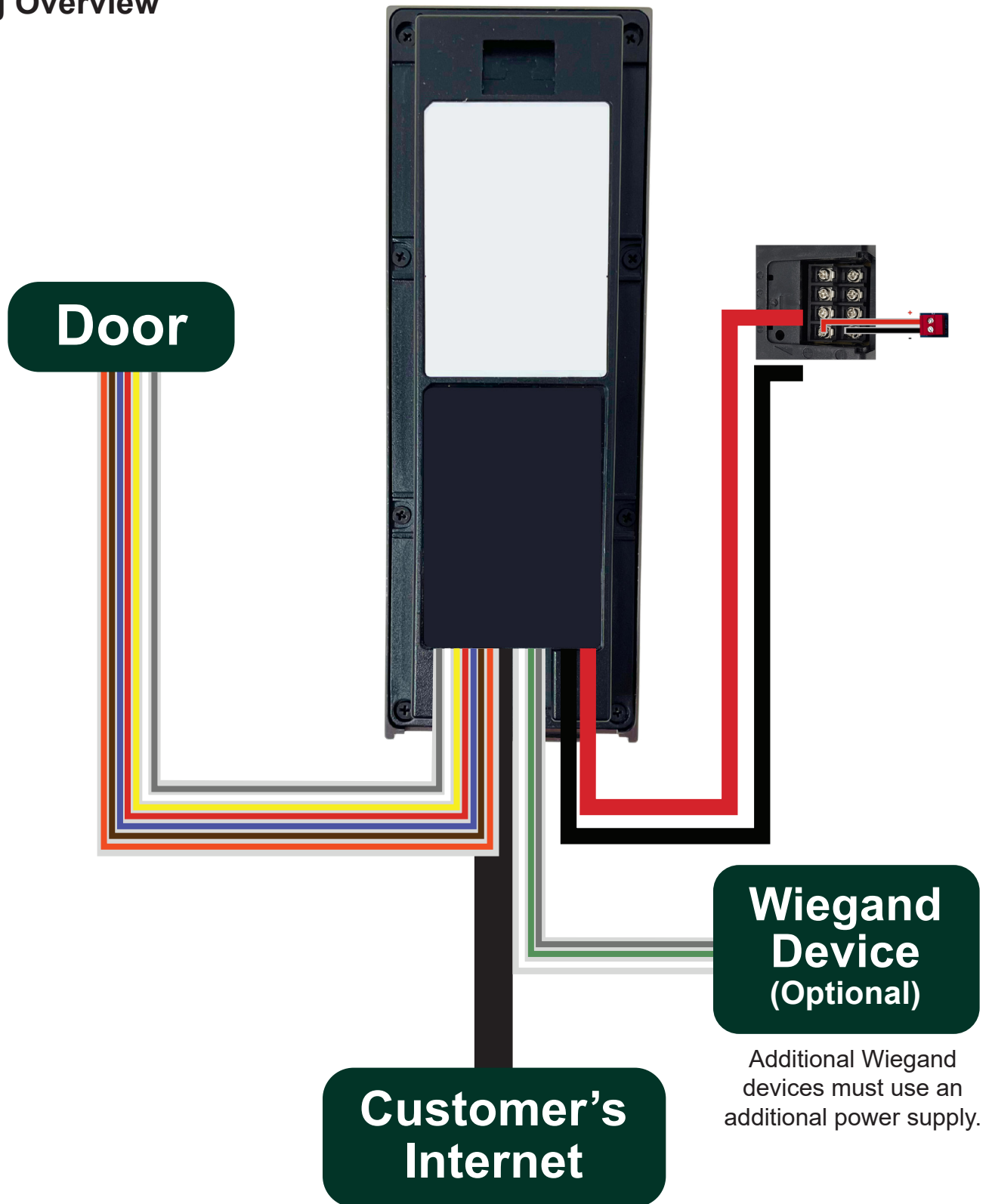



Wiring Labels

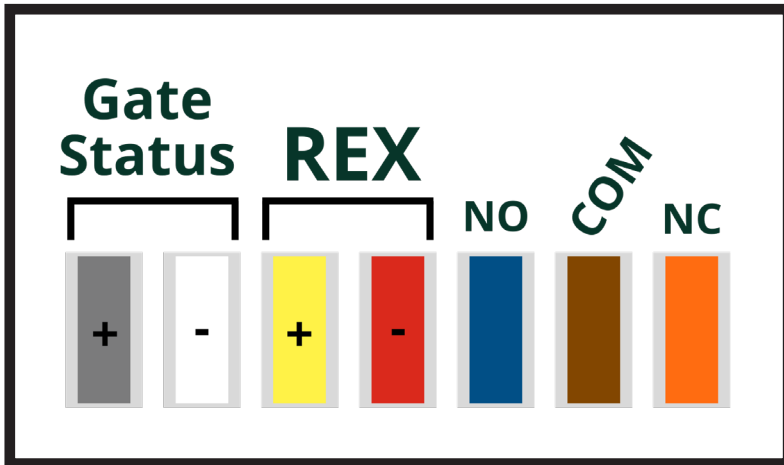

Required wiring: 18/4 conductor stranded and shielded for optional Wiegand devices.

Dry Contact Relay, Normally Open



Dry Contact Relay, Normally Closed





You must use a diode to maintain warranty.
Refer to CellGate's diode instructions.

Wet Contact Relay, Normally Open

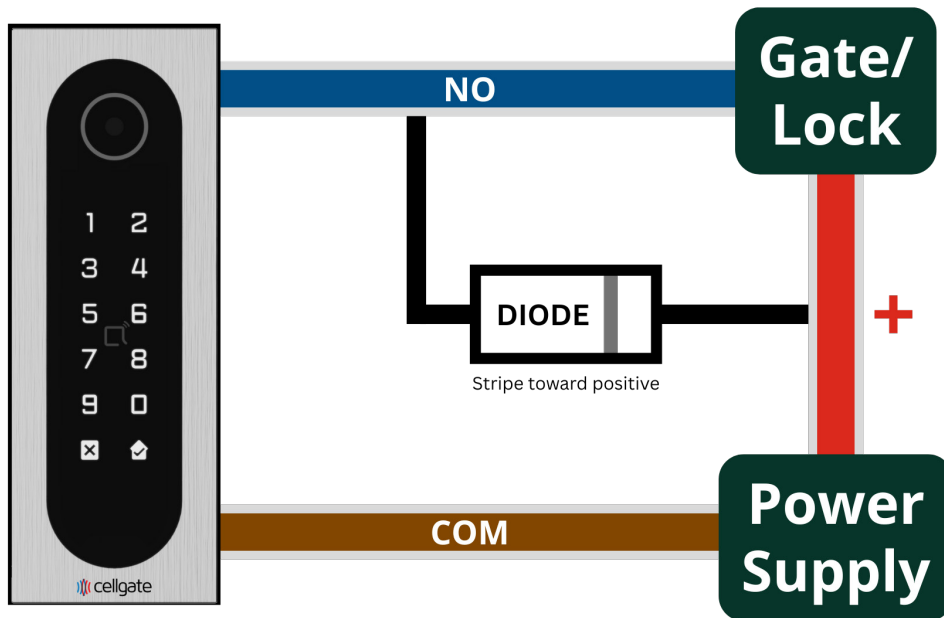

Wet Contact Relay, Normally Closed

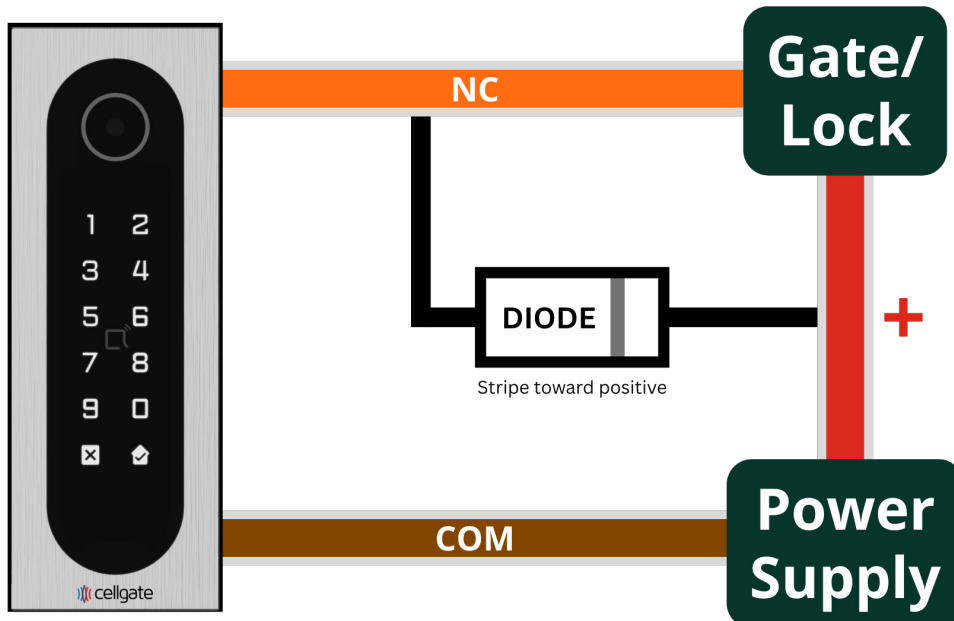



Mounting

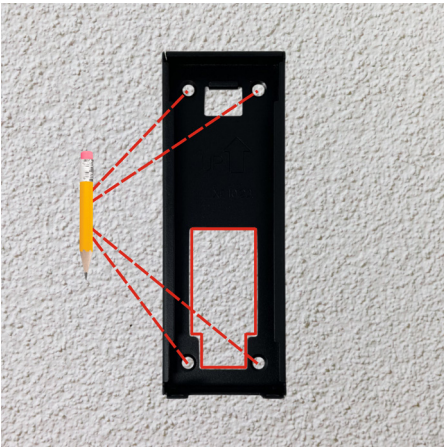

1. Place the mullion mount onto the wall. Mark the screw holes and wiring hole.

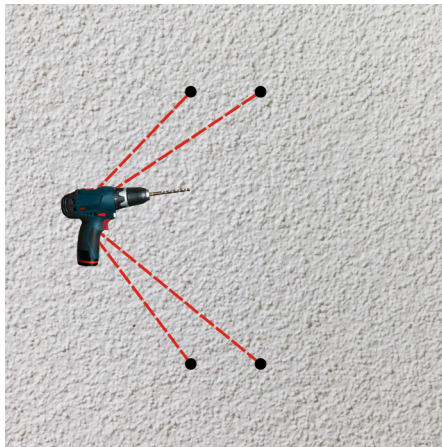

2. Remove the mount and drill out the screw holes.

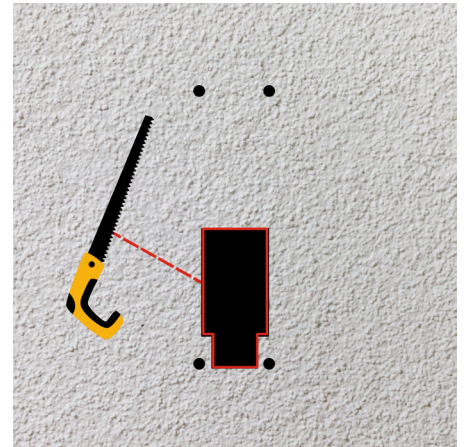

3. Cut the wiring hole with a wallboard saw.

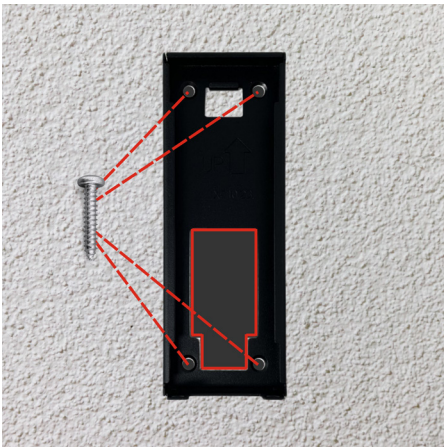

4. Place the mount onto the wall and secure with screws.



5. Slide the Entría device into place and secure with screws in the bottom.